



WINDOW REPLACEMENT INSTRUCTIONS FOR SINGLE-HUNG, DOUBLE-HUNG, CASEMENT, AWNING INTO EXISTING DOUBLE-HUNG FRAME USING FRAME SCREWS FROM THE EXTERIOR

These instructions were tested and developed for replacing windows in wood-frame wall construction systems designed to manage moisture. **This method of installation involves removing the sash, frame stops and frame hardware from the existing window. The original window frame will remain in place.** If existing window frame shows signs of water infiltration or is damaged beyond repair, this method should not be followed and the entire existing window should be removed. Installation recommendations for other types of wall construction, wall systems, conditions, multiple windows or bow/bay windows, may be obtained from Pella Corporation or a local Pella retailer. Building designs, construction methods, building materials, and site conditions unique to your project may require an installation method different from these instructions and additional care on your part. Determining the appropriate installation method is the responsibility of you, your architect, or other construction professional.

YOU WILL NEED TO SUPPLY:

- Cedar or Impervious shims/spacers (12 to 20)
- Closed cell foam backer rod/sealant backer (12 to 30 ft.)
- Pella® SmartFlash™ foil backed butyl window and door flashing tape or equivalent
- Pella Window and Door Installation Sealant or equivalent high quality, multi-purpose sealant (1 tube per window)
- Low expansion, low pressure polyurethane insulating window and door foam sealant. DO NOT use high pressure or latex foams
- #8 x 2-1/2" Wood screws (6 to 10 per window)
- Pella replacement window sill adapter

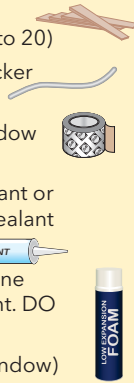

TOOLS REQUIRED:

- Tape measure
- Level
- Sealant gun
- Prybar
- Utility knife
- Putty knife
- Hammer
- Screwdrivers (Flat & Phillips)
- Adjustable pliers
- Side cutters
- Roto-tool, reciprocating saw
- Wood chisel
- 18" drill bit
- Drill

Installation will require two or more persons for safety reasons.

REMEMBER TO USE APPROPRIATE PERSONAL PROTECTIVE EQUIPMENT.

CAUTION: Many windows in older homes are painted with lead-based paint. Removal of old windows may disturb this paint. Proper precautions must be taken to minimize exposure to dust and debris. Consult state or local authorities for more information.

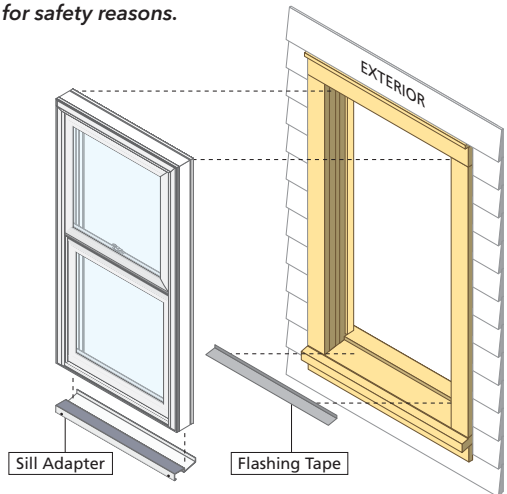

Always read the Pella® Impervia® Limited Warranty before purchasing or installing Pella Impervia products. By installing this product, you are acknowledging that this Limited Warranty is part of the terms of the sale. Failure to comply with all Pella Impervia installation and maintenance instructions may void your Pella Impervia product warranty. See Limited Warranty for complete details at <http://warranty.pellaimpervia.com>.

1 REMOVE THE EXISTING SASH

Note: Remove the new window from its packaging. Inspect and measure the new window to confirm it will fit into the opening prior to removing the existing window. The window needs to be 1/2" smaller in both width and height than the pocket frame, i.e. existing sash opening.

- A. **Unlock the existing window.** Raise the lower sash and lower the upper sash so both are in the approximate middle of the frame.

Note: Most of the following steps may be completed from the exterior of the house.

- B. **Remove the head parting stop.** Remove any head parting stop by pulling the stop down from the frame. In some cases, the stops are nailed on and can simply be pulled off. In other situations the stops may need to be pried or cut out of the frame.

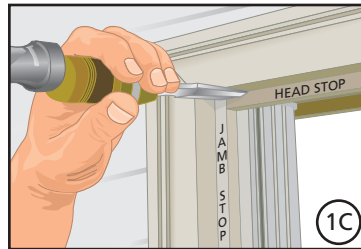
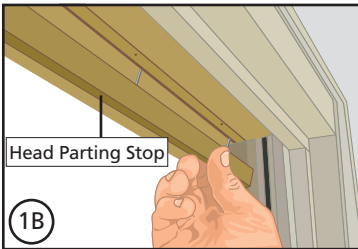

- C. **Remove the exterior jamb and head stops.** This can be accomplished with a wood chisel, circular saw, reciprocating saw, roto-tool, or equivalent. Ensure the stop is removed flush with the existing window jamb.

Caution: Take care to prevent existing sashes from falling out when removing stops.

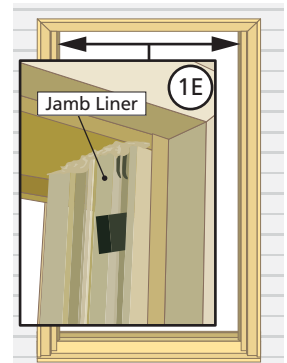
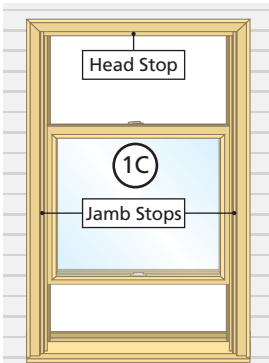

- D. **Remove the upper and lower sash.** This will vary per manufacturer of existing windows. Some will simply pull out, while others may need to be cut to be removed. Grasp the sash and pull out of the frame. The jamb liner material may come out of the frame when pulling the sash out.
- E. **Remove any and all jamb liner material.** Some liners may have frame attachment fasteners that will need to be removed before the liners can be removed.

Caution: Spring loaded balances can cause injury; use care when removing balances from existing windows.

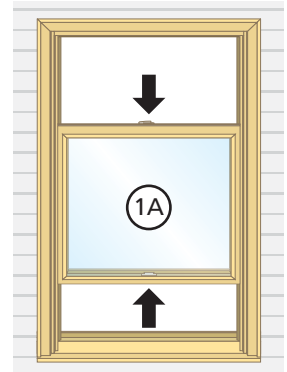

2 OPENING PREPARATION

- A. **Inspect the existing window frame** and repair or replace any defective or rotted wood parts.
- B. **Clean the opening** of any dirt, debris, or excess old paint before proceeding.
- C. **Apply one piece of flashing tape to the sill** of the existing window. Cut the tape the same length as the width of the existing window sill. Place one side of the tape against the vertical leg of the stool, and work the tape into the corner before applying to the sill. Press down firmly. The tape will not cover the sill depth completely under the new window.

Note: If needed, blocking/shims may need to be placed where the existing balances were located.

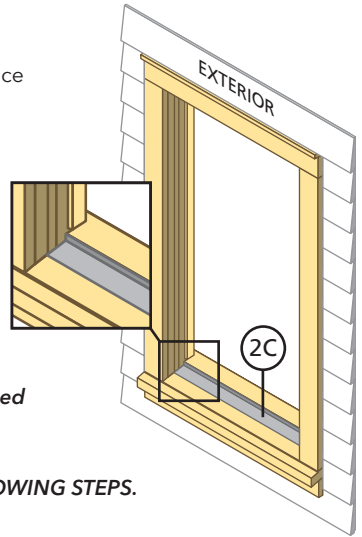

TWO OR MORE PEOPLE ARE REQUIRED FOR THE FOLLOWING STEPS.

3 WINDOW PREPARATION (AWNING and CASEMENT ONLY)



The interior frame covers must be removed to provide access to the pre-drilled frame screw installation holes.

CAUTION: To Avoid Interior Frame Cover Breakage - Carefully read and understand the following steps before proceeding with cover removal.

Note: The following interior frame cover removal steps are for Casement, Standard Awning, Fixed Awning/Casement and Large Awning. The steps are similar for each, but the order in which covers are removed will vary depending on the window type.

The order of interior frame cover removal is indicated below. Use reverse order for re-installation of covers.

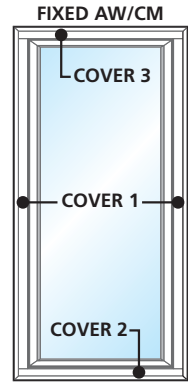
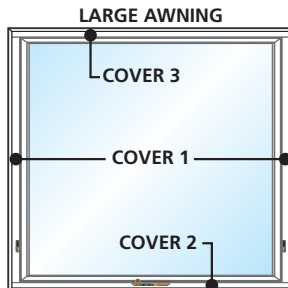
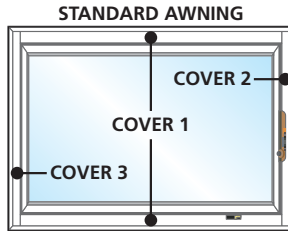
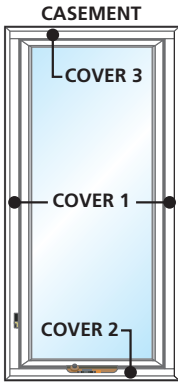



A. Prepare the Window.

1. Remove the screen and set aside.
2. Use pliers to remove the plug(s) from the lock handle location(s).
3. Remove the construction handle tool from the handle package.

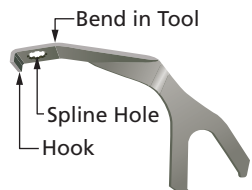
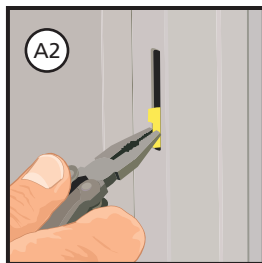

Construction Handle Tool
REFERENCE DESCRIPTION

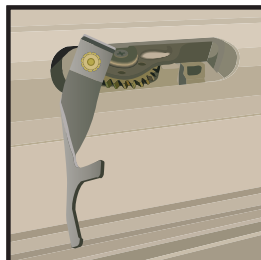
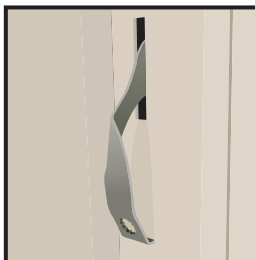

Construction Handle Tool may be used as a lock handle or crank handle.

- B. **Remove Interior Frame Cover #1.** If an Interior Frame Cover has a "Quick Release Band" around the cover, pull the band to help remove the cover.

The cover on vent units where the lock handle slot is located and the cover on the opposite frame side.

Note: Interior Frame Covers #1 are jamb covers on Casement, Fixed Awning/Casement and Large Awning units. On Standard Awning units, Interior Frame Covers #1 are the head and sill covers.

1. Approximately 1" from the bottom (end) of the cover, insert the "hooked" end of the tool between the cover and the sash.
2. Rotate the tool toward the sash and continue to insert the tool past the spline hole up to the point where the bend in the tool is aligned with the edge of the cover.

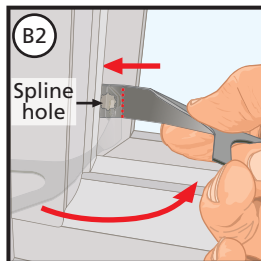
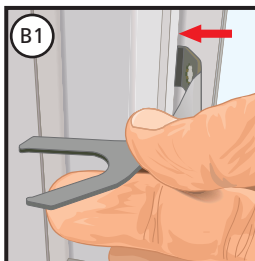

Note: When the tool is inserted with the bend aligned with the cover edge there will be a slight gap between the tool and the face of the sash.

3. Push the tool flat against the sash (not a lot of force is needed) to release the back cover barb from the frame kerf behind the cover. While keeping tension on the tool, pull the tool away from the frame to start releasing the cover bars from the frame kerfs.

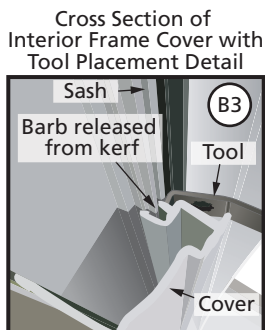
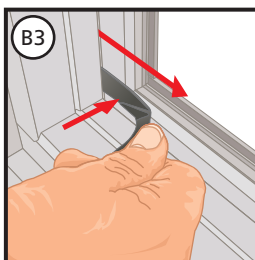



4. Rotate the cover end slightly toward the interior; when the cover begins to pull away from the frame, relocate the tool under the cover towards the interior as shown, then pull the tool away from the frame to continue the release of the cover bars from the frame.
5. Reposition the tool with the hook under the front edge of the cover. Slide the tool over while pulling the cover away from the frame. This will release the flexible bars on the interior side of the cover, which will aid in cover removal. Continue sliding along the length of the cover while pulling it away from the frame until it is removed.

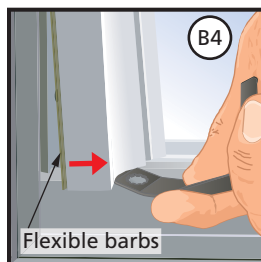

6. Repeat Steps B1 thru B5 to remove the other Interior Frame Cover #1.

If installing a single Casement, Large Awning or Fixed unit less than 42" in width, go to Step E.

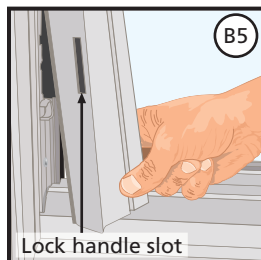
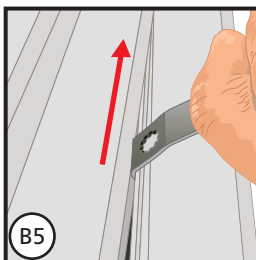

If installing a Standard Awning, multiple window combinations, or units greater than 42" in width, go to Step C.

C. Remove Interior Frame Cover #2.

The cover on vent units where the crank handle and roto-cover will be located.

For Standard Awning, single units greater than 42" in height and multiple window combinations.

1. Starting at the cover end closest to where the crank handle will be located, insert the tool between the sash and cover (using the same method of insertion used for Interior Frame Covers #1).

Note: Insert the tool under Interior Frame Cover #2 next to the FRAME CORNER (C2).

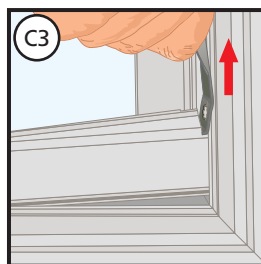
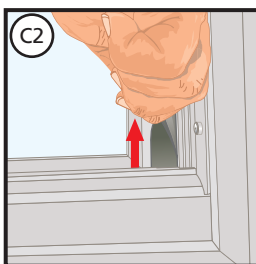

2. Pull the tool away from the frame to start releasing the cover bars from the frame kerfs.
3. When the cover begins to pull away from the frame, relocate the tool near the end of the cover as shown and continue to pull up to release the bars from the kerfs.
4. When the cover has been released near the crank handle cut-out, reposition the tool with the hook under the front edge of the cover. Slide the tool over while pulling up on the cover. Continue along the length of the cover until it is removed.

Note: Take note of the cover support bracket around the roto operator hardware, (on the sill of casement and large awning units and on the jamb of standard awning units) as the cover support bracket will be referenced when re-installing Interior Frame Cover #2.

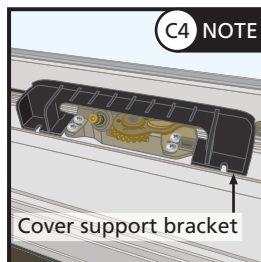
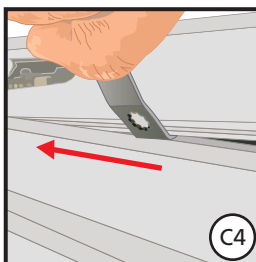



D. Remove Interior Frame Cover #3.

The cover on vent units on the opposite frame side from where the crank handle is located.

For Standard Awning greater than 42" in width, single units greater than 42" in height and multiple window combinations.

1. Start at one end of the cover and insert the tool between the frame and cover as shown.
2. Pull the tool away from the frame to start releasing the cover barbs from the frame kerfs.
3. When the cover begins to pull away from the frame, grasp the cover and continue to pull to release the barbs from the kerfs, removing the cover.

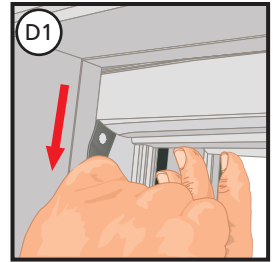

TWO OR MORE PEOPLE ARE REQUIRED FOR THE FOLLOWING STEPS

4 SEALING AND FASTENING THE WINDOW

- A. If the existing double-hung has a sloped sill**, the sill of the new window will need to be supported by using the Pella replacement sill adapter accessory or by using wood blocking as needed.
- B. If using the Pella replacement sill adapter accessory:**

Dry fit the window, temporarily fasten or with someone holding it in place, confirm the window will fit. From the exterior, measure the distance from the bottom of the window to the existing sill.

If 15/16" or > no adjustment to the sill adapter is needed.

If 13/16" to 15/16" break off at the first score mark.

If 5/8" to 13/16" break off at the second score mark.

Remove the window from the opening. Measure the width of the window and cut the sill adapter to the same length. Apply the sill adapter by sliding it into the fin groove.

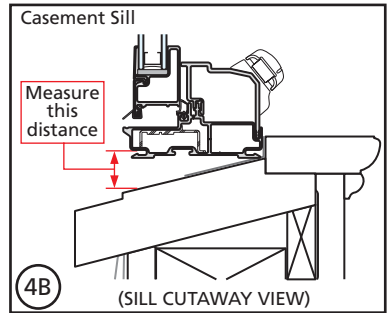

- C. Apply a 3/8" bead of sealant at the point where the existing stool meets the existing window sill.** Additionally, place sealant at the ends of the flashing tape, making sure to connect with the stool sealant.

- D. Apply a continuous 3/8" diameter bead of sealant at the exterior surface of the interior head and jamb stops.** Connect this bead of sealant to the sealant line on the stool.

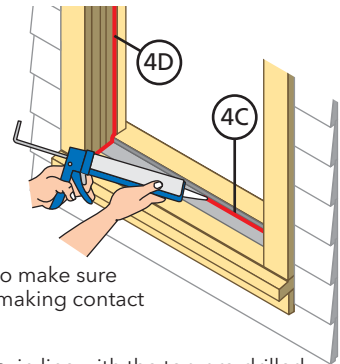

- E. Insert the replacement window** in the opening. Check to make sure the window rests against the interior blind stops and is making contact with the sealant.

- F. From the exterior, place shims near the top of one jamb**, in line with the top pre-drilled hole in the window frame. Partially insert one 2-1/2" wood screw. Repeat the process for the other jamb.

Note: Position shims to ensure they allow at least 1/2" from the exterior surface of the window to allow for placement of backer rod and sealant.

- G. Casement Units Only** - If additional installation holes are needed; drill a 3/16" installation hole through both the interior and exterior walls of the frame.

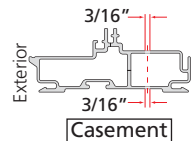

Double-Hung & Single-Hung - If additional installation holes are needed; drill a 5/32" installation hole through both the interior and exterior walls of the frame. Counter drill a 3/8" hole through the interior wall only of the frame. DO NOT penetrate the exterior wall with the 3/8" bit.

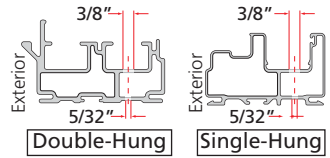

- H. **From the exterior, continue placing shims at each pre-drilled hole as needed to plum and square the window.** Check window for squareness by making sure the diagonal measurements from corner to corner of the replacement window is within 1/8" in both directions. Insert a 2-1/2" wood screw into each pre-drilled hole in the frame. Screws are installed from the interior. Finish inserting the top screw in each jamb.

For Awning and Casement: See Awning/Casement Shim and Fastener Guide.

Note: DO NOT shim above the window. DO NOT over shim!

- I. **Check operation** before applying the insulating foam sealant in case adjustments need to be made.

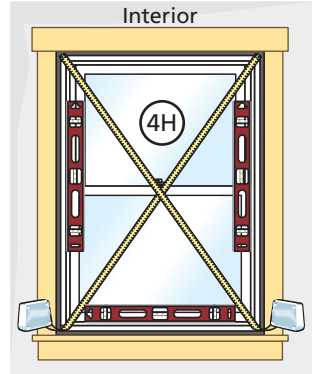

AWNING AND CASEMENT ONLY

Drive screws per the Awning/Casement Shim and Fastener Guide.

AWNING/CASEMENT SHIM and FASTENER PLACEMENT GUIDE

Number of factory drilled fastener locations may vary depending on size of unit(s).

- ▶ = Indicates typical locations of factory drilled anchor holes where screws and shims are required.
- ▷ = Indicates location where installation screws are optional.

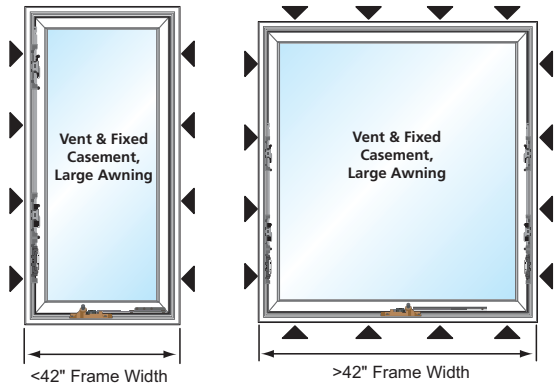

At combination mullion joints:
Drill a 3/16" pilot hole through the mullion plates at the factory drilled anchor holes prior to inserting screws.

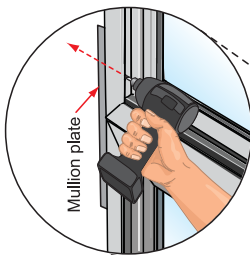

If Frame Width <42", top and bottom screws are optional

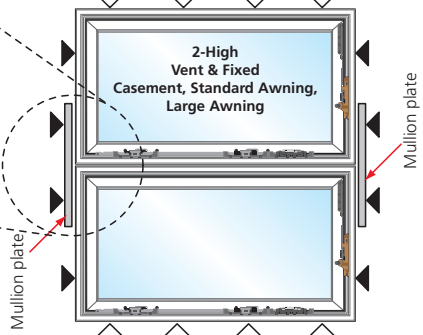

Number of factory drilled fastener locations may vary depending on size of unit(s).

▶ = Indicates typical locations of factory drilled anchor holes where screws and shims are required.

▷ = Indicates location where installation screws are optional.

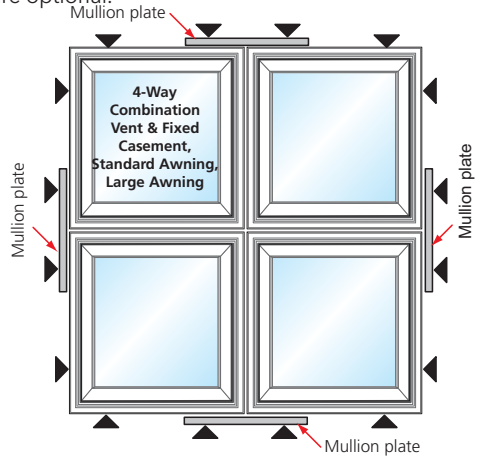
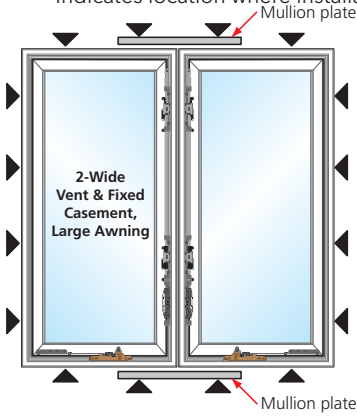

If Frame Width <42", top and bottom screws are optional

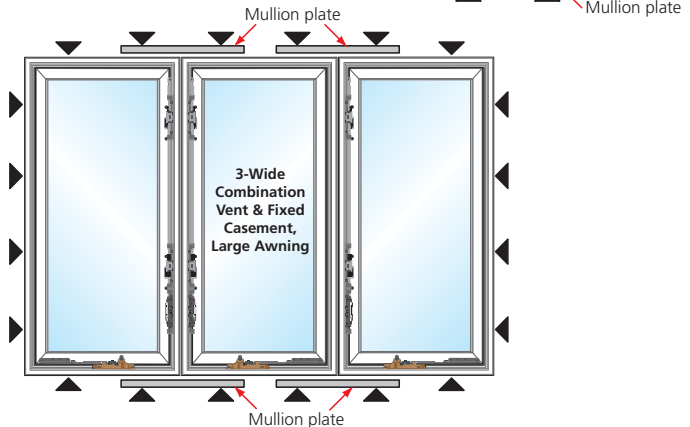
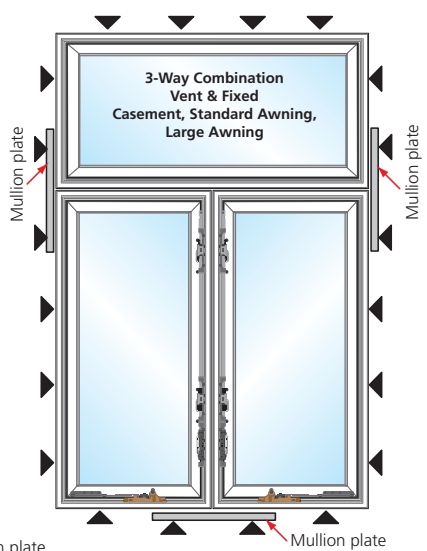
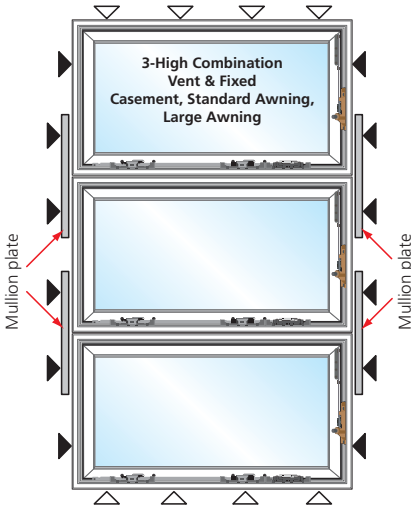



- J. **Insert the construction handle into the lock lever location** and unlock the window. Remove the handle. Place the construction crank handle over the roto operator stud. Open and close each sash to verify the smooth operation and alignment of sash locks with sash strikes. Check and adjust shims as needed. Remove the construction handle.

Re-install Interior Frame Covers.

Note: Discard all Quick Release Bands before re-installing Interior Frame Covers.

- K. **Interior Frame Cover #3** (Head cover on Casement, Fixed and Large Awning and the jamb cover without roto cover cut-out on Standard Awning units):

Starting on one end of the frame, insert the cover barbs of Interior Frame Cover #3 into the frame kerfs. Align the kerfs along the length of the cover and press until the cover "clicks" into place.

Note: Interior Frame Cover #3 contains compression springs which allow the cover to be compressed when re-installing Interior Frame Cover #1 in Step 4M.

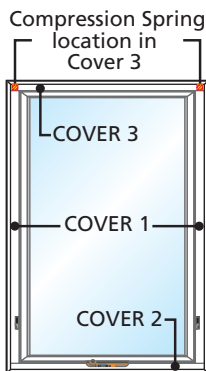
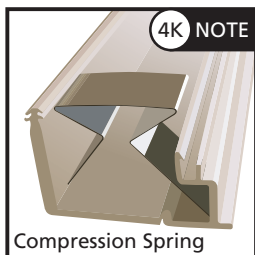

- L. **Interior Frame Cover #2** (Sill cover on Casement, Fixed and Large Awning and a jamb cover with roto cover cut-out on Standard Awning units):

Place the cover support referenced in Step C4 inside the cover as shown. While holding the support in place, position the cover to align the cover barbs with the frame kerfs. Press the cover barbs into the kerfs while working toward the roto operator. Continue to hold the support in place to ensure proper placement of the support over the operator. Press the cover until it "clicks" into place.

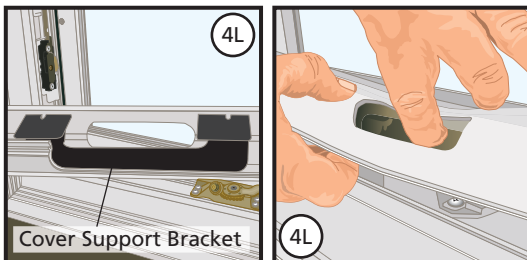

Note: The cover support bracket may need to be repositioned over the roto operator. The correct support position allows the cover barbs to be fully seated into the frame kerfs.

- M. **Interior Frame Cover #1** (Jamb covers on Casement, Fixed and Large Awning and the head and sill covers on Standard Awning units):

Insert the cover barbs of the first Interior Frame Cover #1 into the frame kerfs near Interior Frame Cover #2 first. Rotate the Interior Frame Cover #1 towards Interior Frame Cover #3 and align the kerfs along the frame, then press the cover until it "clicks" into place. Repeat on the other cover.

- N. **Insert the roto cover, crank handle and lock handle.** See steps at the end of the instructions.

5 INTERIOR SEAL

CAUTION: Ensure use of low pressure polyurethane window and door insulating foams and strictly follow the foam manufacturer's recommendations for application. Use of high pressure foams or improper application of the foam may cause the window frame to bow and hinder operation.

- A. **Insulate between new frame** and the existing frame with low expansion insulating foam. FROM THE EXTERIOR insert the nozzle of the applicator approximately 1" from the interior stop and apply a 1" deep bead of foam. This will allow room for the expansion of the foam and will minimize squeeze out. Follow foam manufacturer's instructions. If over filled with foam, the foam must be trimmed back to allow room for backer rod and sealant.

Note: It may be necessary to squeeze the end of the tube with pliers to be able to insert into the space between the window frame and the rough opening.

Note: Masking between the window and the existing interior stop will help alleviate possible squeeze out of the expandable foam to the interior.

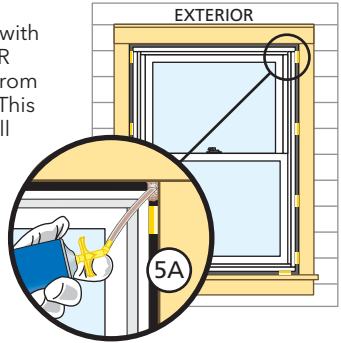

- B. **Check the window operation** (vent units only) by opening and closing the window.

Note: If the window does not operate correctly, check to make sure it is still plumb, level, square, and the jambs are not bowed. If adjustments are required, remove the foam with a serrated knife. Adjust the shims, and reapply the insulating foam sealant.

- C. **Inspect the interior** and carefully trim all excess foam sealant if needed.



- D. **Insert jamb hole plugs** (provided) into each screw hole for single-hung and double-hung units.

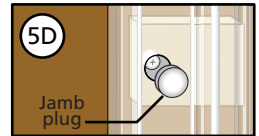

6 EXTERIOR SEAL

- A. **Insert backer rod** into the space around the window at the head and jambs. This should provide at least 3/8" clearance between the backer rod and the exterior face of the window.

Note: Backer rod adds shape and depth for the sealant line.

- B. **Place a bead of sealant** at the jambs and head between the existing window frame and the replacement window frame.

Caution: DO NOT seal the bottom exterior to allow for incidental water to weep.

- C. **Shape, tool, and clean excess sealant.** When finished, the sealant should be the shape of an hourglass.

Note: This method creates a more flexible sealant line capable of expanding and contracting.

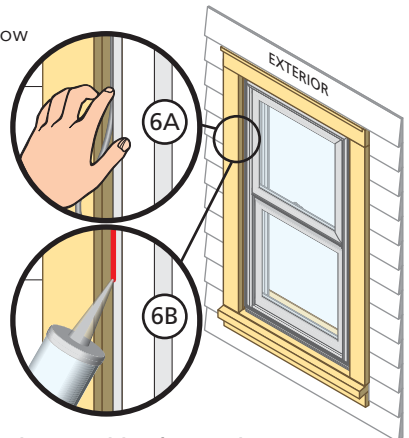

EXTERIOR FINISH OF EXISTING FRAME

The exposed wood and flashing tape on the exterior stop needs to be covered/protected. There are many ways to accomplish this, and each case can be unique.

A few possibilities include:

- Covering the existing trim with aluminum coil wrap/frame expander.
- Sanding, priming and painting to match existing trim.
- Covering the exposed wood with a high quality exterior grade sealant.

Note: *The contractor/installer will determine how to finish the exterior.*

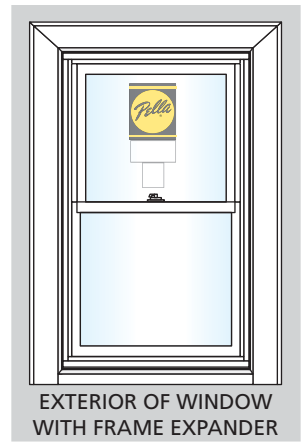

AWNING AND CASEMENT ONLY



INSTALLING ROTO COVER AND CRANK

- Place the cover over the operator stud and snap into place.
- Apply pressure to the pocket end of the cover and snap into place.
- Use a medium size flat-blade screwdriver to loosen the set screw in the crank handle.
- Slide the crank handle onto the stud. Unlock, open window, then close and lock window.
- Fold the crank handle down and check alignment of knob with the pocket.

Note: *You may need to adjust the crank position on the stud until the correct alignment is achieved.*

- Open the crank and tighten the set screw.
- After the final installation, fold the crank over and snap the knob into the pocket.

Note: *Even with the window open the crank can be folded to avoid interfering with the window treatments.*

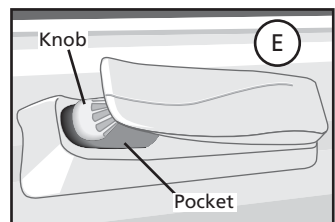
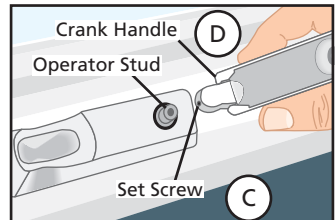
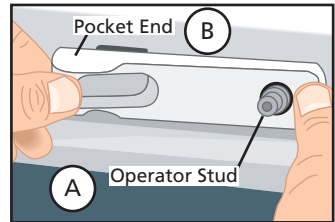



LOCK LEVER REMOVAL AND INSERTION

Note: You may want to remove the lock lever if it needs to be replaced with a different finish.

- A. Unlock and open the window.
- B. Place the lock lever in the locked position.
- C. From the exterior of the window, look through the opening behind the lock lever to locate the point where the lock lever and lock cam meet.
- D. Insert an approximately 1/4" wide flat-blade screwdriver straight into the opening and center the blade tip at the point the cam and lever meet.
- E. Push the screwdriver against the lock cam and rotate the bottom of the blade toward the lock lever. This will push the lock cam away from the lock lever hook so the lever can be removed.
- F. Remove the lock lever by pulling it straight out toward the interior of the building.
- G. To install a lock lever, from the interior hold it in the locked position and insert into the slot until it snaps onto the cam.

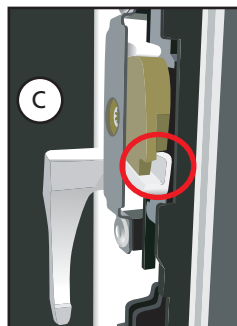
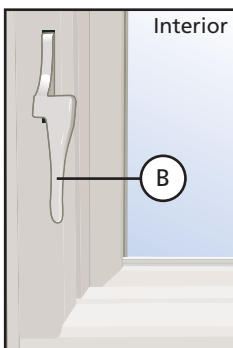

Stop removed to show the lever and cam.

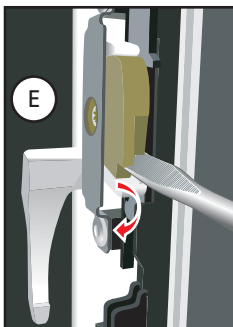

Stop removed to show orientation of screwdriver between the lever and cam.

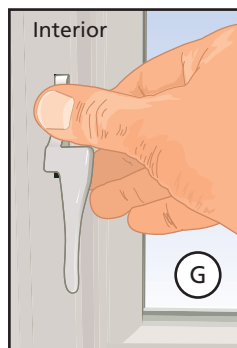

Note: The lock cam must be in the locked position before the lock lever can be inserted.

FINISH

The interior and exterior frame and sash are protected by a powder coat baked-on factory finish that requires no painting. Clean this surface with mild soap and water. Stubborn stains and deposits may be removed with mineral spirits. DO NOT use abrasives. DO NOT scrape or use tools that might damage the surface.

Use of inappropriate solvents, brickwash or cleaning chemicals will cause adverse reactions with window and door materials and voids the Limited Warranty.

CARE AND MAINTENANCE

Care and maintenance information is available by contacting your local Pella retailer. This information is also available at www.pellaimpervia.com.

IMPORTANT NOTICE

Because all construction must anticipate some water infiltration, it is important that the wall system be designed and constructed to properly manage moisture. Pella Corporation is not responsible for claims or damages caused by anticipated and unanticipated water infiltration; deficiencies in building design, construction and maintenance; failure to install Pella® products in accordance with Pella installation instructions; or the use of Pella products in wall systems which do not allow for proper management of moisture within the wall systems. The determination of the suitability of all building components, including the use of Pella products, as well as the design and installation of flashing and sealing systems are the responsibility of the Buyer or User, the architect, contractor, installer, or other construction professional and are not the responsibility of Pella.

Pella products should not be used in barrier wall systems which do not allow for proper management of moisture within the wall systems, such as barrier Exterior Insulation and Finish Systems, (EIFS) (also known as synthetic stucco) or other non-water managed systems. Except in the states of California, New Mexico, Arizona, Nevada, Utah, and Colorado, Pella makes no warranty of any kind and assumes no responsibility for Pella windows and doors installed in barrier wall systems. In the states listed above, the installation of Pella products in barrier wall or similar systems must be in accordance with Pella installation instructions.

Product modifications that are not approved by Pella Corporation will void the Limited Warranty.



Part Number: 80YW0102